

# SCORPION

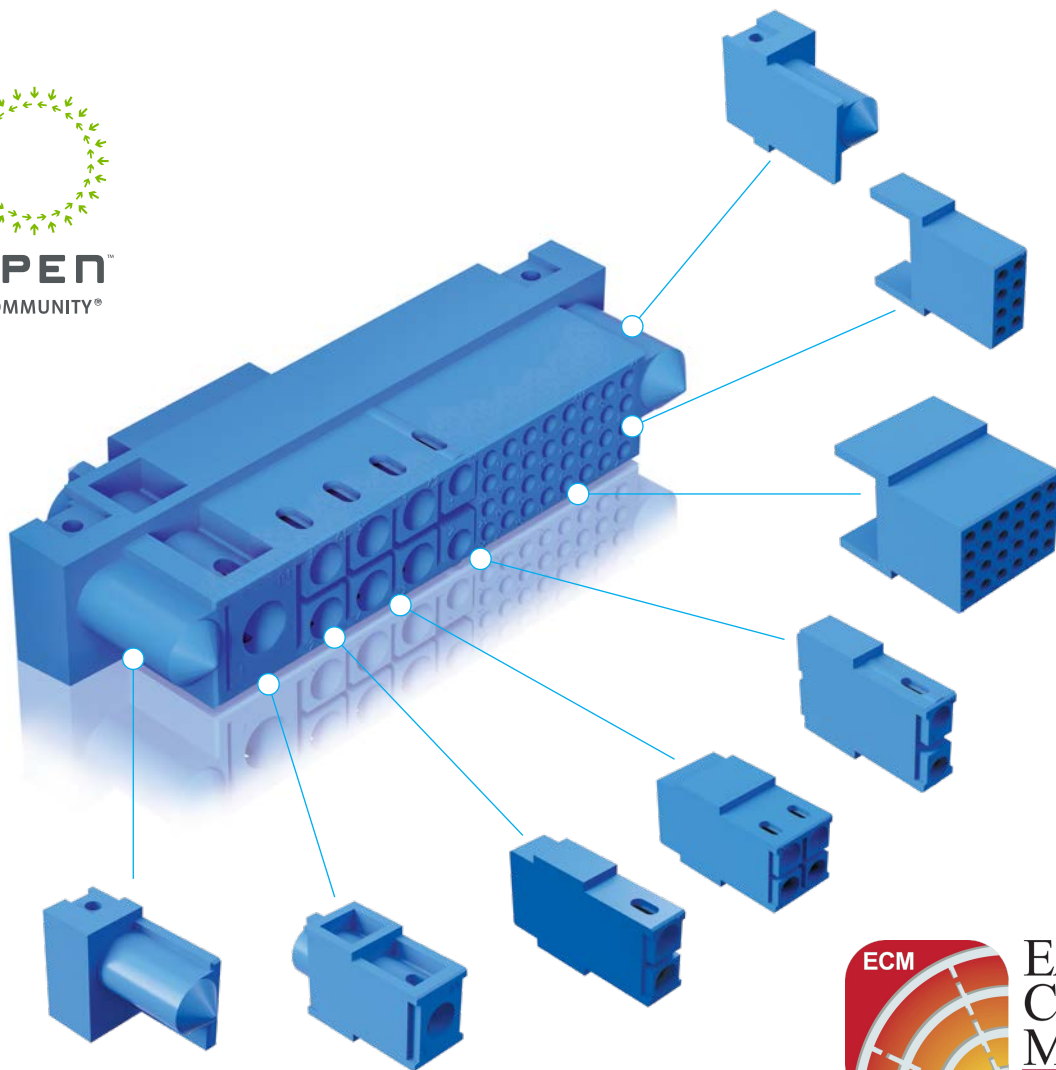

## MODULAR POWER, SIGNAL CONNECTORS

- The most versatile modular power/signal connector on the planet
- Rated up to 100 amperes per contact plus ability to add signal contacts and a variety of accessories
- Venting options for improved air cooling
- Blank modules for greater creepage and clearance for higher voltage needs
- Unique locking systems for blind mating, float mount and cable connector options



**EAST  
COAST  
MICROWAVE**  
SALES AND DISTRIBUTION, LLC.



**Positronic**  
an Amphenol company

Distributed by East Coast Microwave Sales & Distribution LLC  
70 Tower Office Park, Woburn MA 01740

PHONE: 1.800.STOCKROOM - EMAIL: sales@ecmstockroom.com - WEB: www.ecmstockroom.com

THE SCIENCE OF **CERTAINTY**<sup>®</sup>

M015 Rev A 19/10

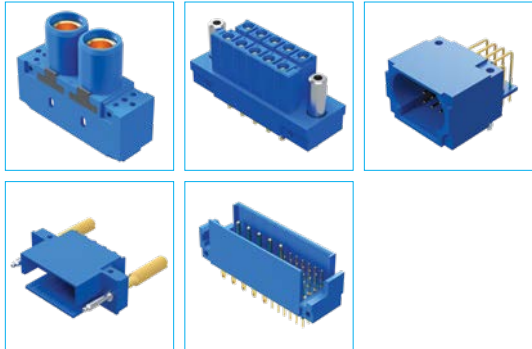
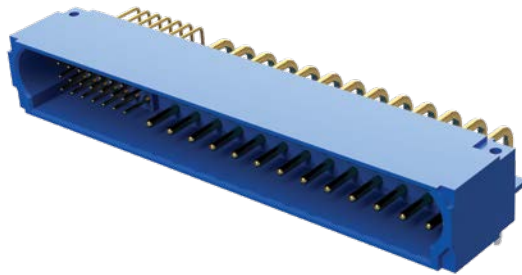

**Scorpion** brings a unique approach to modular connector design that is only available from Positronic. **Scorpion** provides the flexibility to configure the connector to meet your specifications. The difference is how Positronic builds the final connector, using our innovative tooling and injection molding process. The result is a **Scorpion** with solid body and machined contacts, ready to perform.

Trust the **Scorpion** to deliver ***The Science of Certainty***

## TECH SPECS

### GENERAL

Part Number Prefix	SP
Performance Level	Industrial Mil/aero
Qualifications	UL #E49351*1  *1 Partial UL certification only. Contact Technical Sales for specific connector qualifications and for UL status of Hyperboloid contacts.

### MATERIAL

Insulator Material	Polyester
Insulator Color	Blue
Flammability Rating	UL94 V-0
Contact Material	Copper alloy
Contact Plating	Gold flash 0.76µm Au (min) 1.27µm Au (min)

### ELECTRICAL

Working Voltage (rms)	100 V to 1000 V	
Initial Contact Resistance	Power	0.2 mΩ*1
	Signal	5 mΩ
Contact Current Rating*2	Power	Up to 100A*1
	Signal	3A*3

\*1 Value established using high conductivity alloy  
\*2 See page 9-10 for temperature rise curves  
\*3 Hyperboloid contacts 0.60 [0.0236] rated to 4A

### MECHANICAL

Contact Style	Fixed Removable
Female Contact Design	Open entry Closed entry
Mating Cycles*1	Up to 1000

\*1 Hyperboloid contacts up to 100,000

### ENVIRONMENTAL

Operating Temperature	-55 to 125°C
-----------------------	--------------

# OVERALL LENGTH (OAL)

## HOW TO CALCULATE OAL

Overall Length (OAL) of a connector is the sum of all the modules' length. Refer to example below for OAL maximum calculation. See page 6-8 for individual module dimensions.

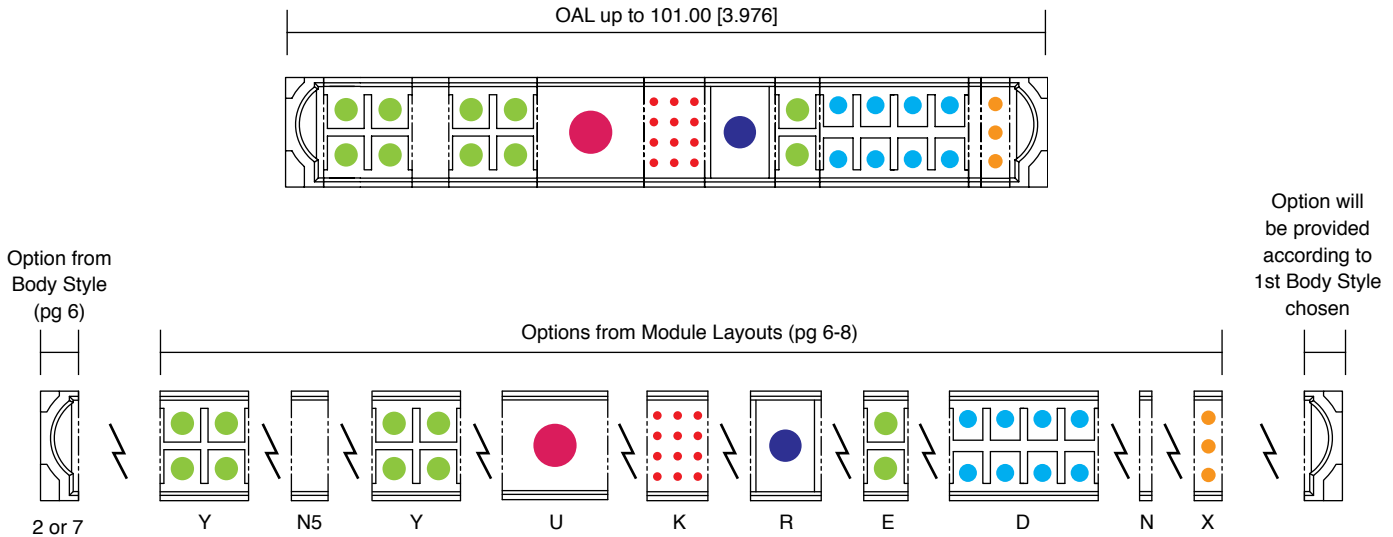

- A Scorpion part number can be a maximum of 30 characters. If the connector configuration exceeds this number, please contact Technical Sales for a special part number for your unique requirement.
- Pinout sequence may not be continuous. Contact Technical Sales for more information.
- Contact Technical Sales for connector length exceeding 101.00 [3.976].
- For connectors offering both fixed solder and crimp contacts, contact Technical Sales.
- Alignment bar is only available for size 16, size 18, size 22, and hyperboloid Ø0.60 [0.0236] right angle contacts.
- PosiBand contacts available for size 12, 16, 18 and 22.
- If there are more than 36 signal pins in one connector, customer will need to take note of the tolerances and alignment issues.



PICMG® logo is a registered trademark of the PCI Industrial Computers Manufacturers Group.

Positronic is proud to participate in PICMG 3.8. The Scorpion series was chosen as the PICMG 3.8 power connector.

## CREATE A PART

Mating connector part numbers will have the same letters in the same order. Female connector modules are placed right to left; Male modules are placed left to right when viewed from their mating faces.

	<b>SP</b>	<b>1</b>	<b>UU</b>	<b>1</b>	<b>M</b>		
Series							
SP Scorpion							
Body Style <small>For more information, refer to page 6</small>							
<p><i>Skip this step, if no end modules are required</i> *1</p> <p><b>Blind Mating</b></p> <p>1 Blind mating, 3.80 [0.150] misalignment                  2 Blind mating, 2.00 [0.079] misalignment                  7 Blind mating, 2.00 [0.079] misalignment (use for code 0, BS or N in Mounting Options step)                  8 Extreme blind mating, up to 3.90 [0.154] misalignment, up to 5° angular misalignment</p> <p><b>Latching System</b></p> <p>3 Locking latch, use with female free cable to male cable                  4 Locking latch, use with male free cable to female panel mount (wire or PCB)                  5 Locking latch, use with female free cable to male panel mount (wire or PCB)</p> <p><b>Jackscrews</b></p> <p>6 For use with jackscrew system</p> <p><small>*1 If using a backshell on this connector, you must choose N5 in Layout step as first and last modules and skip the Body Style step. Consult Technical Sales for backshell availability for connector without end modules.</small></p>							
Layout <small>For more information, refer to pages 7-8</small>							
<p><b>One or more modules can be selected in this section to create desired contact layout</b></p> <table border="0" style="width: 100%;"> <tr> <td style="width: 50%; vertical-align: top;"> <p><b>Contact Module</b></p> <p><b>U</b> (1) #4 contact  <b>R</b> (1) #8 contact  <b>S</b> (2) #8 contacts  <b>E</b> (2) #12 contacts  <b>Y</b> (4) #12 contacts  <b>A</b> (1) #16 contacts  <b>B</b> (2) #16 contacts  <b>C</b> (4) #16 contacts  <b>D</b> (8) #16 contacts  <b>X</b> (3) #18 contacts  <b>Z</b> (6) #18 contacts  <b>H</b> (4) #22 contacts  <b>J</b> (8) #22 contacts  <b>K</b> (12) #22 contacts  <b>T</b> (24) #22 contacts</p> </td> <td style="width: 50%; vertical-align: top;"> <p><b>Hyperboloid</b></p> <p><b>V</b> (10) Hyperboloid Ø0.60 [0.0236]*1  <b>W</b> (20) Hyperboloid Ø0.60 [0.0236]*1</p> <p><b>Keying</b></p> <p><b>0</b> Keying module</p> <p><b>Blank module</b></p> <p><b>N</b> Spacer/blank  <b>N2</b> Spacer/blank  <b>N3</b> Spacer/blank  <b>N4</b> Spacer/blank  <b>N5</b> Spacer/blank*2</p> <p><small>*1 Unique high density contact design with machined pin diameter Ø0.60 [0.0236], for straight and right angle (90°) PCB mount only. Contact Technical Sales for availability of crimp terminal.                      *2 For a backshell application, use code N5 next to each body style module.</small></p> </td> </tr> </table>						<p><b>Contact Module</b></p> <p><b>U</b> (1) #4 contact  <b>R</b> (1) #8 contact  <b>S</b> (2) #8 contacts  <b>E</b> (2) #12 contacts  <b>Y</b> (4) #12 contacts  <b>A</b> (1) #16 contacts  <b>B</b> (2) #16 contacts  <b>C</b> (4) #16 contacts  <b>D</b> (8) #16 contacts  <b>X</b> (3) #18 contacts  <b>Z</b> (6) #18 contacts  <b>H</b> (4) #22 contacts  <b>J</b> (8) #22 contacts  <b>K</b> (12) #22 contacts  <b>T</b> (24) #22 contacts</p>	<p><b>Hyperboloid</b></p> <p><b>V</b> (10) Hyperboloid Ø0.60 [0.0236]*1  <b>W</b> (20) Hyperboloid Ø0.60 [0.0236]*1</p> <p><b>Keying</b></p> <p><b>0</b> Keying module</p> <p><b>Blank module</b></p> <p><b>N</b> Spacer/blank  <b>N2</b> Spacer/blank  <b>N3</b> Spacer/blank  <b>N4</b> Spacer/blank  <b>N5</b> Spacer/blank*2</p> <p><small>*1 Unique high density contact design with machined pin diameter Ø0.60 [0.0236], for straight and right angle (90°) PCB mount only. Contact Technical Sales for availability of crimp terminal.                      *2 For a backshell application, use code N5 next to each body style module.</small></p>
<p><b>Contact Module</b></p> <p><b>U</b> (1) #4 contact  <b>R</b> (1) #8 contact  <b>S</b> (2) #8 contacts  <b>E</b> (2) #12 contacts  <b>Y</b> (4) #12 contacts  <b>A</b> (1) #16 contacts  <b>B</b> (2) #16 contacts  <b>C</b> (4) #16 contacts  <b>D</b> (8) #16 contacts  <b>X</b> (3) #18 contacts  <b>Z</b> (6) #18 contacts  <b>H</b> (4) #22 contacts  <b>J</b> (8) #22 contacts  <b>K</b> (12) #22 contacts  <b>T</b> (24) #22 contacts</p>	<p><b>Hyperboloid</b></p> <p><b>V</b> (10) Hyperboloid Ø0.60 [0.0236]*1  <b>W</b> (20) Hyperboloid Ø0.60 [0.0236]*1</p> <p><b>Keying</b></p> <p><b>0</b> Keying module</p> <p><b>Blank module</b></p> <p><b>N</b> Spacer/blank  <b>N2</b> Spacer/blank  <b>N3</b> Spacer/blank  <b>N4</b> Spacer/blank  <b>N5</b> Spacer/blank*2</p> <p><small>*1 Unique high density contact design with machined pin diameter Ø0.60 [0.0236], for straight and right angle (90°) PCB mount only. Contact Technical Sales for availability of crimp terminal.                      *2 For a backshell application, use code N5 next to each body style module.</small></p>						
Termination <small>For more information, refer to page 8</small>							
1 Wire, order contacts separately*1 3 Straight solder 38 Straight solder, high conductivity power contacts 93 Straight press-fit, for use with PCB not thinner than 2.29 [0.090]*2 938 Straight press-fit, for use with PCB not thinner than 2.29 [0.090], high conductivity power contacts*2 4 Right angle solder 48 Right angle solder, high conductivity power contacts							
<p><small>*1 To order contacts separately, see pages 11-13 for contact part numbers.                      *2 For contacts size 8, 12, 16, 18 and 22 only. Contact Technical Sales for press-fit tooling part number.</small></p>							
Contact Gender							
M Male pin F Female socket, open and closed entry signal contacts S Female socket, PosiBand closed entry signal contacts							

CREATE A PART

<b>0</b>	<b>B</b>	<b>9</b>	<b>1</b>	<b>/AA</b>
----------	----------	----------	----------	------------

Environmental Compliance

**/AA** RoHS 5/6 (< 4% lead)

Contact Plating

**1** Wire, order contacts separately  
**A1** Gold flash over 1.27µm Ni (nominal) over Cu  
**A2** Gold flash over 1.27µm Ni (nominal) over Cu, solder coat tails\*<sup>1</sup>  
**C1** 0.76µm Au (min) over 1.27µm Ni (nominal) over Cu  
**C2** 0.76µm Au (min) over 1.27µm Ni (nominal) over Cu, solder coat tails\*<sup>1</sup>  
**D1** 1.27µm Au (min) over 1.27µm Ni (nominal) over Cu  
**D2** 1.27µm Au (min) over 1.27µm Ni (nominal) over Cu, solder coat tails\*<sup>1</sup>

\*<sup>1</sup> Not for use with code 93 or 938 in Termination step.

For more information, refer to page 15

Optional Features

**0** Not vented  
**9** Vented for improved cooling\*<sup>1</sup>

\*<sup>1</sup> Not for use with module A in Layout step or with signal contacts.

For more information, refer to pages 14-15

Mounting Options & Locking Systems

**0** None  
**B** Angle brackets, clearance hole\*<sup>1</sup>  
**LN** Angle brackets, boardlocks\*<sup>1</sup>  
**BS** Angle brackets, threaded\*<sup>1</sup>  
**TB** Angle brackets, fixed female jackposts\*<sup>1</sup>  
**TLN** Angle brackets, boardlocks, fixed female jackposts\*<sup>1</sup>  
**N** Boardlocks\*<sup>2</sup>  
**TN** Boardlocks, fixed female jackposts  
**E** Rotating male jackscrews  
**T** Fixed female jackposts  
**W** Backshell\*<sup>3</sup>  
**WE** Backshell, rotating male jackscrews \*<sup>3</sup>

\*<sup>1</sup> For use with right angle PCB mount using code 4 or 48 in Termination step.  
\*<sup>2</sup> For use with straight and right angle PCB mount using code 3, 38, 4 or 48 in Termination step.  
\*<sup>3</sup> For use with two N5 spacer modules in Layout step, one spacer will be needed on each end of connector.

For more information, refer to page 14

Panel Mount

**0** None  
**1** 2-56 threaded insert\*<sup>1</sup>  
**2** 4-40 threaded insert\*<sup>2</sup>  
**82** Float mount, 0.60 [0.024] per side, 1.50 [0.059] panel thickness\*<sup>3</sup>  
**821** Float mount, 2-56 threaded insert, 0.60 [0.024] per side, 1.50 [0.059] panel thickness\*<sup>1</sup>  
**822** Float mount, 4-40 threaded insert, 0.60 [0.024] per side, 1.50 [0.059] panel thickness\*<sup>2</sup>  
**823** Float mount, 2-56 threaded insert, 1.20 [0.047] per side, 1.50 [0.059] panel thickness \*<sup>4</sup>  
**824** Float mount, 4-40 threaded insert, 1.20 [0.047] per side, 1.50 [0.059] panel thickness\*<sup>2</sup>  
**83** Float mount, 2.30 [0.091] panel thickness\*<sup>3</sup>  
**831** Float mount, 2-56 threaded insert, 0.60 [0.024] per side, 2.30 [0.091] panel thickness\*<sup>1</sup>  
**832** Float mount, 4-40 threaded insert, 0.60 [0.024] per side, 2.30 [0.091] panel thickness\*<sup>2</sup>  
**833** Float mount, 2-56 threaded insert, 1.20 [0.047] per side, 2.30 [0.091] panel thickness\*<sup>4</sup>  
**834** Float mount, 4-40 threaded insert, 1.20 [0.047] per side, 2.30 [0.091] panel thickness\*<sup>2</sup>

\*<sup>1</sup> For use with code 1 or 2 in Body Style step.  
\*<sup>2</sup> For use with code 8 in Body Style step.  
\*<sup>3</sup> For use with code 1, 2, 4 or 5 in Body Style step, contact Technical Sales for more floating options.  
\*<sup>4</sup> For use with code 1 in Body Style step, contact Technical Sales for more floating options.

## BODY STYLE

For the sake of brevity, only the left side of the end module face view is shown.

Scale 1:1

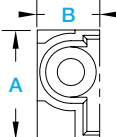
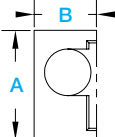
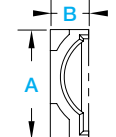
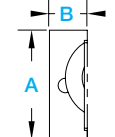
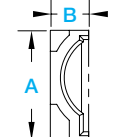
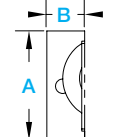
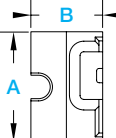
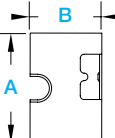
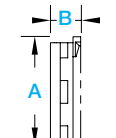
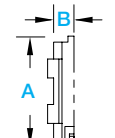
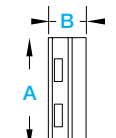
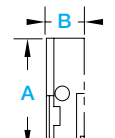
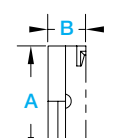
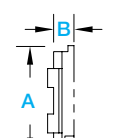
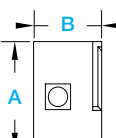
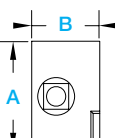
MALE	FEMALE	CODE	GENDER	A	B	FEATURE
		1	Male	14.60 [0.575]	8.26 [0.325]* <sup>1</sup>	Blind mating
			Female	14.60 [0.575]	8.26 [0.325]* <sup>1</sup>	Blind mating
		2	Male	14.60 [0.575]	5.00 [0.197]* <sup>1</sup>	Blind mating
			Female	14.60 [0.575]	5.00 [0.197]* <sup>1</sup>	Blind mating
		7	Male	14.60 [0.575]	4.50 [0.177]* <sup>1</sup>	Blind mating
			Female	14.60 [0.575]	4.50 [0.177]* <sup>1</sup>	Blind mating
		8	Male	14.60 [0.575]	9.50 [0.374]* <sup>1</sup>	Blind mating
			Female	14.60 [0.575]	9.50 [0.374]* <sup>1</sup>	Blind mating
		3	Male	14.60 [0.575]	4.00 [0.157]* <sup>1</sup>	Latching system
			Female	14.60 [0.575]	2.80 [0.110]* <sup>1</sup>	Latching system
		4	Male	14.60 [0.575]	4.76 [0.157]	Latching system
			Female	14.60 [0.575]	5.00 [0.197]* <sup>1</sup>	Latching system
		5	Male	14.60 [0.575]	5.00 [0.197]* <sup>1</sup>	Latching system
			Female	14.60 [0.575]	2.80 [0.110]* <sup>1</sup>	Latching system
		6	Male	14.60 [0.575]	9.20 [0.362]* <sup>1</sup>	Jackscrew
			Female	14.60 [0.575]	9.20 [0.362]* <sup>1</sup>	Jackscrew

Images below are shown for reference only, not shown at 1:1 scale.

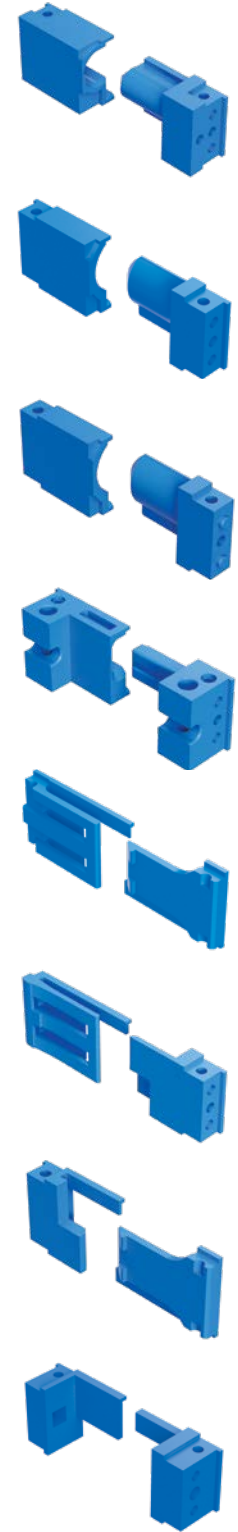

\*1 Double dimension for OAL. Dimension shown is only for one module, but connector will be provided with two modules, one left and one right.

**MODULE LAYOUTS\*1**

\*1 All modules shown are male modules. Contact Technical Sales for availability of other modules.

Scale 1:1

CONTACT MODULES	CODE	SIZE	A	B
	U	#4	14.60 [0.575]	14.20 [0.559]
	R	#8	14.60 [0.575]	9.40 [0.370]
	S	#8	14.60 [0.575]	18.80 [0.740]
	E	#12	14.60 [0.575]	5.90 [0.232]
	Y	#12	14.60 [0.575]	11.80 [0.465]
	A	#16	14.60 [0.575]	4.96 [0.195]
	B	#16	14.60 [0.575]	4.96 [0.195]
	C	#16	14.60 [0.575]	9.92 [0.391]
	D	#16	14.60 [0.575]	19.84 [0.781]

CONTACT MODULES	CODE	SIZE	A	B
	X	#18	14.60 [0.575]	3.80 [0.150]
	Z	#18	14.60 [0.575]	7.60 [0.299]
	H	#22	14.60 [0.575]	2.70 [0.106]
	J	#22	14.60 [0.575]	5.40 [0.213]
	K	#22	14.60 [0.575]	8.10 [0.319]
	T	#22	14.60 [0.575]	16.20 [0.638]

Contact Size Chart						
#4	#8	#12	#16	#18	#22	0.60mm





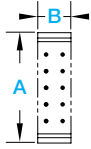
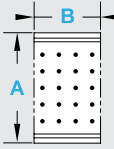

All Positronic products utilize solid, machined contacts.

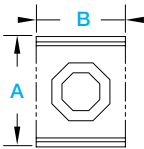
## MODULE LAYOUTS

Scale 1:1

HYPERBOLOID MODULES 0.60 [0.0236]	CODE	A	B
	V	14.60 [0.575]	4.40 [0.173]
	W	14.60 [0.575]	8.80 [0.346]

KEYING MODULE	CODE	A	B
	O	14.60 [0.575]	11.80 [0.465]

Contact Size Chart						
#4	#8	#12	#16	#18	#22	0.60mm
						

All Positronic products utilize solid, machined contacts.

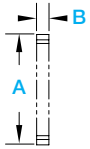
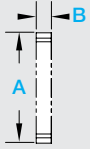
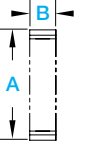
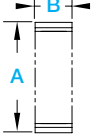
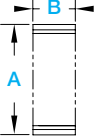
BLANK MODULES	CODE	A	B
	N	14.60 [0.575]	1.62 [0.064]
	N2	14.60 [0.575]	2.00 [0.079]
	N3	14.60 [0.575]	3.46 [0.136]
	N4	14.60 [0.575]	4.88 [0.192]
	N5	14.60 [0.575]	5.60 [0.220]

## CONTACT TERMINATIONS DIMENSIONS

For the sake of brevity, only the Male single row size 8 contact modules are shown. Dimension shown apply for all contacts regardless of size and gender.

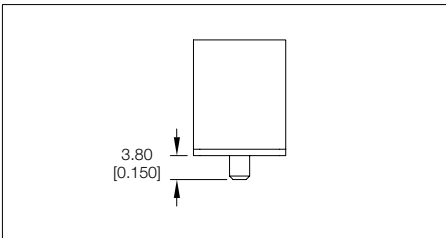
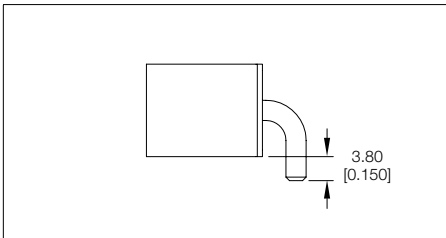
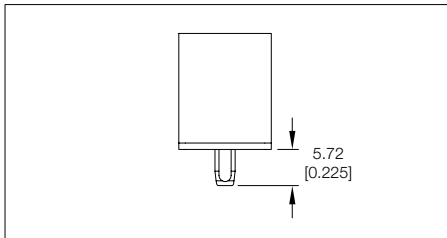
STRAIGHT SOLDER	RIGHT ANGLE SOLDER	PRESS-FIT*1
		

\*1 For information of suggested straight mount PCB hole sizes, please visit our website to [download SK 6370](#).



## MATING DIMENSIONS

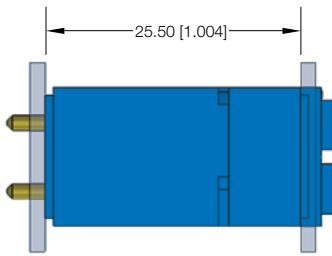

Straight PCB mount (Male) to Panel Mount Crimp (Female)

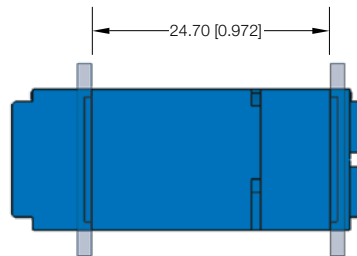

Panel Mount Crimp (Male) to Panel Mount Crimp (Female)

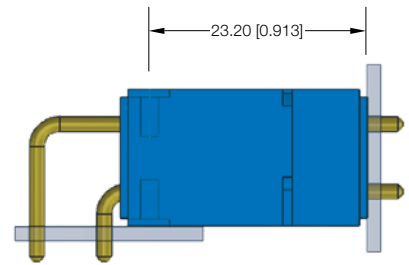

Right Angle Board Mount (Male) to Straight PCB Mount (Female)

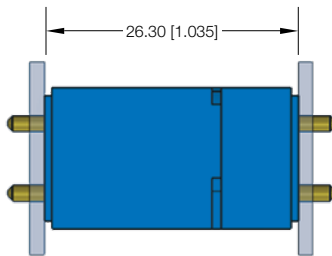

Straight PCB Mount (Male) to Straight PCB Mount (Female)

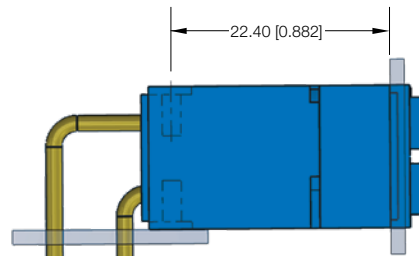

Right Angle Board Mount (Male) to Panel Mount Crimp (Female)

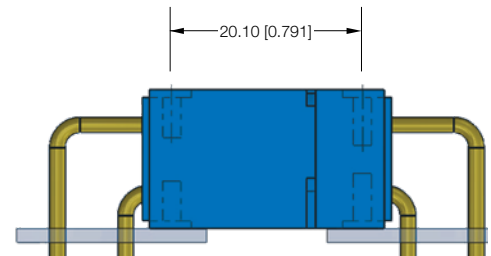

Right Angle Board Mount (Male) to Right Angle Board Mount (Female)

## TEMPERATURE RISE CURVES

Tested per IEC Publication 60512-3, Test 5a

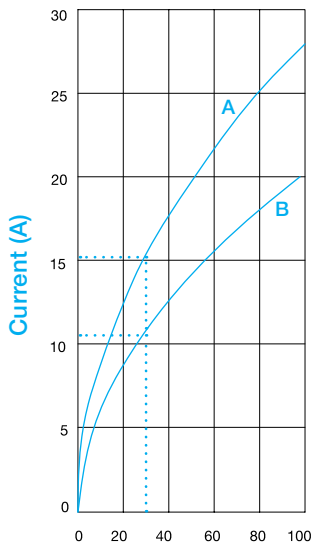

### Size 18 Temperature rise (°C)

- A** Developed with (6) #18 high conductivity contacts seated in code Z modules.
- B** Developed with (6) #18 standard conductivity contacts seated in code Z modules.

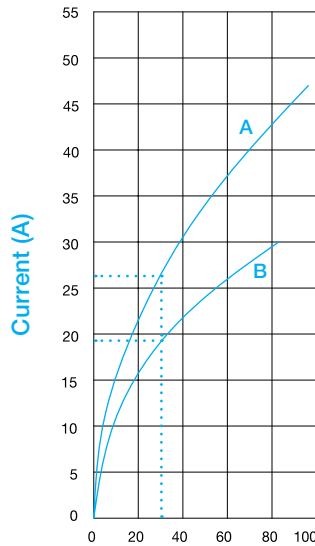

### Size 16 Temperature rise (°C)

- A** Developed with (2) #16 high conductivity contacts seated in code B modules.
- B** Developed with (2) #16 standard conductivity contacts seated in code B modules.

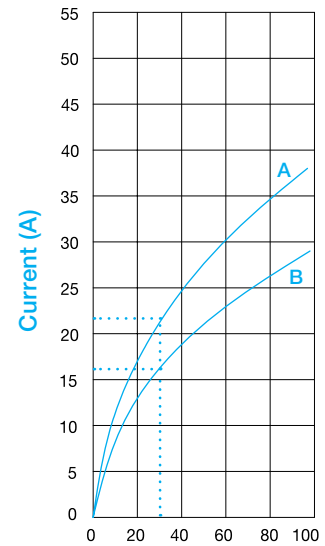

### Size 16 Temperature rise (°C)

- A** Developed with (8) #16 high conductivity contacts seated in code CC modules.
- B** Developed with (8) #16 standard conductivity contacts seated in code CC modules.

## TEMPERATURE RISE CURVES

Tested per IEC Publication 60512-3, Test 5a

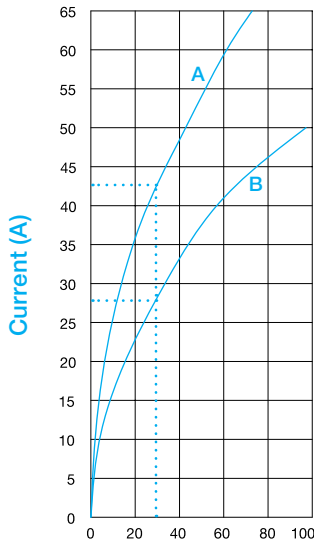

**Size 12 Temperature rise (°C)**

- A** Developed with (2) #12 high conductivity contacts seated in code E modules.
- B** Developed with (2) #12 standard conductivity contacts seated in code E modules.

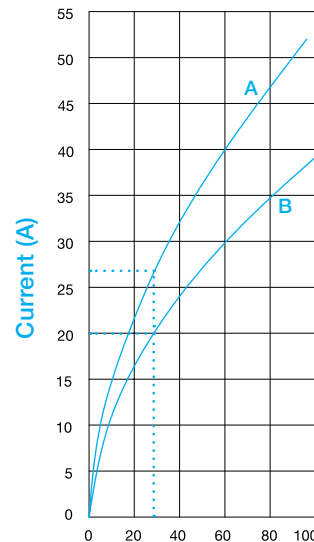

**Size 12 Temperature rise (°C)**

- A** Developed with (10) #12 high conductivity contacts seated in code EYY modules.
- B** Developed with (10) #12 standard conductivity contacts seated in code EYY modules.

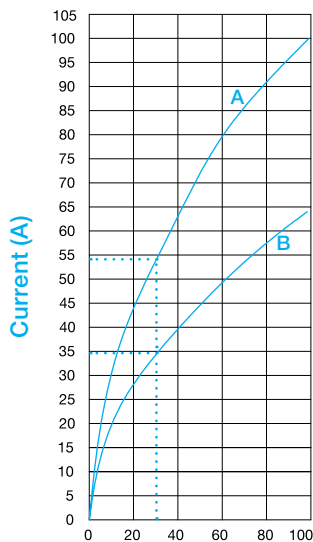

**Size 8 Temperature rise (°C)**

- A** Developed with (2) #8 high conductivity contacts seated in code RR modules.
- B** Developed with (2) #8 standard conductivity contacts seated in code RR modules.

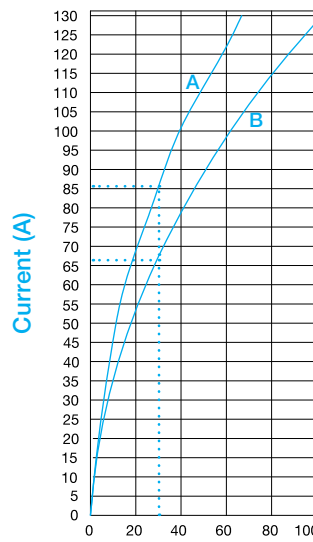

**Size 4 Temperature rise (°C)**

- A** Developed with (2) #4 high conductivity contacts seated in code UU modules.
- B** Developed with (2) #4 standard conductivity contacts seated in code UU modules.

**CONTACTS<sup>\*1</sup>**

**SC** Standard conductivity contacts  
**HC** High conductivity contacts

\*1 Contact Technical Sales for more details on additional contact sizes, material, finishes, and termination styles.

**REMOVABLE CRIMP CONTACTS**

PART NUMBER		Size	Gender	Female Contact Style	Stranded AWG [mm <sup>2</sup> ]	Sequential Mate
FC0404N2	SC	#4	Female	Closed entry	#4 [25.0]	
FC0404N2S	HC	#4	Female	Closed entry	#4 [25.0]	
MC0404N	SC	#4	Male	n/a	#4 [25.0]	
MC0404NS	HC	#4	Male	n/a	#4 [25.0]	
FC4008DS	HC	#8	Female	Closed entry	#8 [10.0]	
FC4008DS-PA781	HC	#8	Female	Closed entry	#8 [10.0]	First
FC4010D	SC	#8	Female	Closed entry	#10 [5.3]	
FC4010D-PA781	SC	#8	Female	Closed entry	#10 [5.3]	First
FC4010DS	HC	#8	Female	Closed entry	#10 [5.3]	
FC4010DS-PA781	HC	#8	Female	Closed entry	#10 [5.3]	First
FC4012D	SC	#8	Female	Closed entry	#12 [4.0]	
FC4012D-PA781	SC	#8	Female	Closed entry	#12 [4.0]	First
FC4012DS	HC	#8	Female	Closed entry	#12 [4.0]	
FC4012DS-PA781	HC	#8	Female	Closed entry	#12 [4.0]	First
FC4016D	SC	#8	Female	Closed entry	#16 [1.5]	
FC4016D-PA781	SC	#8	Female	Closed entry	#16 [1.5]	First
FC4016DS	HC	#8	Female	Closed entry	#16 [1.5]	
FC4016DS-PA781	HC	#8	Female	Closed entry	#16 [1.5]	First
MC4008DS	HC	#8	Male	n/a	#8 [10.0]	
MC4008DS-PA781	HC	#8	Male	n/a	#8 [10.0]	First
MC4010D	SC	#8	Male	n/a	#10 [5.3]	
MC4010D-PA781	SC	#8	Male	n/a	#10 [5.3]	First
MC4010DS	HC	#8	Male	n/a	#10 [5.3]	
MC4010DS-PA781	HC	#8	Male	n/a	#10 [5.3]	First
MC4012D	SC	#8	Male	n/a	#12 [4.0]	
MC4012D-PA781	SC	#8	Male	n/a	#12 [4.0]	First
MC4012DS	HC	#8	Male	n/a	#12 [4.0]	
MC4012DS-PA781	HC	#8	Male	n/a	#12 [4.0]	First
MC4016D	SC	#8	Male	n/a	#16 [1.5]	
MC4016D-PA781	SC	#8	Male	n/a	#16 [1.5]	First
MC4016DS	HC	#8	Male	n/a	#16 [1.5]	
MC4016DS-PA781	HC	#8	Male	n/a	#16 [1.5]	First
FC1210P2	SC	#12	Female	Closed entry	#10 [6.0]	
FC1210P2S	HC	#12	Female	Closed entry	#10 [6.0]	
FC1212P2	SC	#12	Female	Closed entry	#12 [4.0]	
FC1212P2S	HC	#12	Female	Closed entry	#12 [4.0]	
MC1210N-PA563	SC	#12	Male	n/a	#10 [6.0]	First
MC1210NS-PA563	HC	#12	Male	n/a	#10 [6.0]	First
MC1210N	SC	#12	Male	n/a	#10 [6.0]	
MC1210NS	HC	#12	Male	n/a	#10 [6.0]	
MC1212N-PA563	SC	#12	Male	n/a	#12 [4.0]	First
MC1212NS-PA563	HC	#12	Male	n/a	#12 [4.0]	First
MC1212N	SC	#12	Male	n/a	#12 [4.0]	
MC1212NS	HC	#12	Male	n/a	#12 [4.0]	

## CONTACTS\*1

SC	Standard conductivity contacts
HC	High conductivity contacts

\*1 Contact Technical Sales for more details on additional contact sizes, material, finishes, and termination styles.

### REMOVABLE CRIMP CONTACTS

PART NUMBER		Size	Gender	Female Contact Style	Stranded AWG [mm <sup>2</sup> ]	Sequential Mate
FC112P2-PA907	SC	#16	Female	Closed entry	#12 [4.0]	
FC112P2S-PA907	HC	#16	Female	Closed entry	#12 [4.0]	
FC114P2-PA907	SC	#16	Female	Closed entry	#14-16 [2.5-1.5]	
FC116P2-PA907	SC	#16	Female	Closed entry	#16-18-20 [1.5-1.0-0.5]	
FC120P2-PA907	SC	#16	Female	Closed entry	#20-22-24 [0.5-0.3-0.25]	
MC112N-133.5	SC	#16	Male	n/a	#12 [4.0]	First
MC112NS-133.5	HC	#16	Male	n/a	#12 [4.0]	First
MC112N	SC	#16	Male	n/a	#12 [4.0]	
MC112NS	HC	#16	Male	n/a	#12 [4.0]	
MC114N-133.5	SC	#16	Male	n/a	#14-16 [2.5-1.5]	First
MC114N	SC	#16	Male	n/a	#14-16 [2.5-1.5]	
MC116N-133.5	SC	#16	Male	n/a	#16-18-20 [1.5-1.0-0.5]	First
MC116N	SC	#16	Male	n/a	#16-18-20 [1.5-1.0-0.5]	
MC120N-133.5	SC	#16	Male	n/a	#20-22-24 [0.5-0.3-0.25]	First
MC120N	SC	#16	Male	n/a	#20-22-24 [0.5-0.3-0.25]	
FC1816P2	SC	#18	Female	Closed entry	#16-18 [1.5-1.0]	
FC1816P2S	HC	#18	Female	Closed entry	#16-18 [1.5-1.0]	
FC1820P2	SC	#18	Female	Closed entry	#20 [0.5]	
FC1820P2S	HC	#18	Female	Closed entry	#20 [0.5]	
MC1816N-PA561	SC	#18	Male	n/a	#16-18 [1.5-1.0]	First
MC1816NS-PA561	HC	#18	Male	n/a	#16-18 [1.5-1.0]	First
MC1816N	SC	#18	Male	n/a	#16-18 [1.5-1.0]	
MC1816NS	HC	#18	Male	n/a	#16-18 [1.5-1.0]	
MC1820N-PA561	SC	#18	Male	n/a	#20 [0.5]	First
MC1820NS-PA561	HC	#18	Male	n/a	#20 [0.5]	First
MC1820N	SC	#18	Male	n/a	#20 [0.5]	
MC1820NS	HC	#18	Male	n/a	#20 [0.5]	
FC422P9	SC	#22	Female	Closed entry	#22-26 [0.3-0.12]	
MC422N9	SC	#22	Male	n/a	#22-26 [0.3-0.12]	
MC422N9-PA1116*1	SC	#22	Male	n/a	#22-26 [0.3-0.12]	

\*1 For use with alignment insert.

### NON-REMOVABLE CRIMP CONTACTS

PART NUMBER		Size	Gender	Female Contact Style	Stranded AWG [mm <sup>2</sup> ]
FC422T-PA908	SC	#22	Female	Closed entry	#22-26 [0.3-0.12]
MC422T-PA908	SC	#22	Male	n/a	#22-26 [0.3-0.12]

### NON-REMOVABLE HYPERBOLOID CRIMP CONTACTS

PART NUMBER		Size	Gender	Female Contact Style	Stranded AWG [mm <sup>2</sup> ]
FC3124T	SC	0.60 [0.0236]	Female	Closed entry	#24-28 [0.25-0.08]
MC3124T	SC	0.60 [0.0236]	Male	n/a	#24-28 [0.25-0.08]

# CONTACTS\*1

SC	Standard conductivity contacts
HC	High conductivity contacts

\*1 Contact Technical Sales for more details on additional contact sizes, material, finishes, and termination styles.

## REMOVABLE CONTACTS, BUS BAR INTERNAL THREADS

PART NUMBER		Size	Gender	Female Contact Style	Thread
SPFIT04M	SC	#4	Female	Closed entry	M5 x 0.8
SPFIT04MS	HC	#4	Female	Closed entry	M5 x 0.8
SPFIT04S	SC	#4	Female	Closed entry	10-24 UNC 2B
SPFIT04SS	HC	#4	Female	Closed entry	10-24 UNC 2B
SPMIT04M	SC	#4	Male	n/a	M5 x 0.8
SPMIT04MS	HC	#4	Male	n/a	M5 x 0.8
SPMIT04S	SC	#4	Male	n/a	10-24 UNC 2B
SPMIT04SS	HC	#4	Male	n/a	10-24 UNC 2B

Scale 1:1

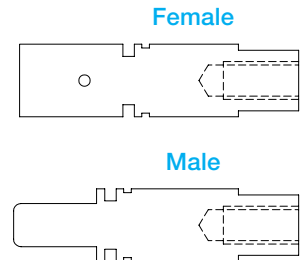

## REMOVABLE CONTACTS, BUS BAR EXTERNAL THREADS

PART NUMBER		Size	Gender	Female Contact Style	Thread
SPFET04M	SC	#4	Female	Closed entry	M5 x 0.8
SPFET04MS	HC	#4	Female	Closed entry	M5 x 0.8
SPFET04S	SC	#4	Female	Closed entry	10-24 UNC 2A
SPFET04SS	HC	#4	Female	Closed entry	10-24 UNC 2A
SPMET04M	SC	#4	Male	n/a	M5 x 0.8
SPMET04MS	HC	#4	Male	n/a	M5 x 0.8
SPMET04S	SC	#4	Male	n/a	10-24 UNC 2A
SPMET04SS	HC	#4	Male	n/a	10-24 UNC 2A

Scale 1:1

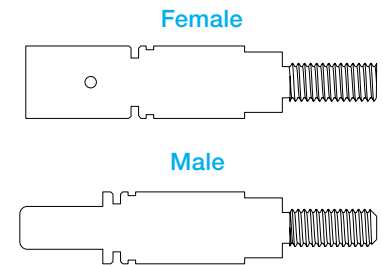

## REMOVABLE CONTACTS, RIGHT ANGLE THREAD FOR RING TERMINAL

PART NUMBER		Size	Gender	Female Contact Style	Thread	Stranded AWG [mm <sup>2</sup> ]
SPFRA04M	SC	#4	Female	Closed entry	M5 x 0.8	#10 [5.3]
SPFRA04MS	HC	#4	Female	Closed entry	M5 x 0.8	#10 [5.3]
SPFRA04S	SC	#4	Female	Closed entry	10-24 UNC 2B	#10 [5.3]
SPFRA04SS	HC	#4	Female	Closed entry	10-24 UNC 2B	#10 [5.3]
SPMRA04M	SC	#4	Male	n/a	M5 x 0.8	#10 [5.3]
SPMRA04MS	HC	#4	Male	n/a	M5 x 0.8	#10 [5.3]
SPMRA04S	SC	#4	Male	n/a	10-24 UNC 2B	#10 [5.3]
SPMRA04SS	HC	#4	Male	n/a	10-24 UNC 2B	#10 [5.3]

Scale 1:1

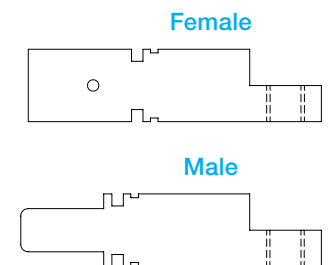

# ACCESSORIES

## PCB MOUNT

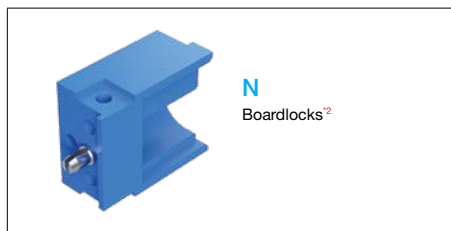
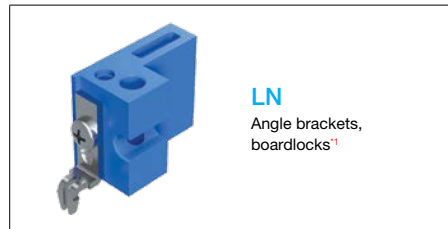
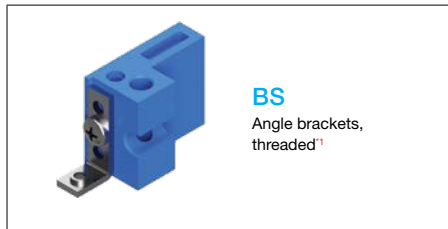
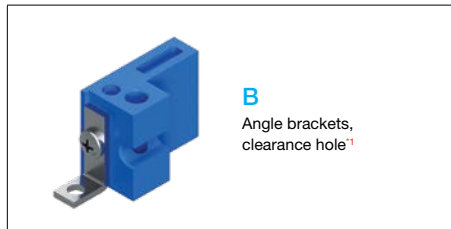

<sup>\*1</sup> For use with right angle PCB mount using code 4 or 48 in Termination step.  
<sup>\*2</sup> For use with straight and right angle PCB mount using code 3, 38, 4 or 48 in Termination step.

CODE	MATERIALS
B, BS, LN	Brass with tin plate
N	Copper alloy with tin plate

## PANEL MOUNT

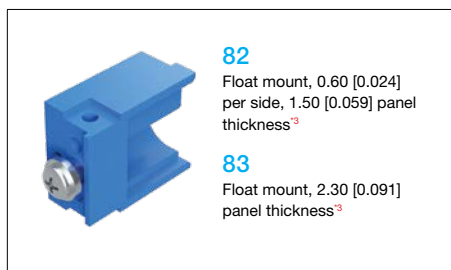
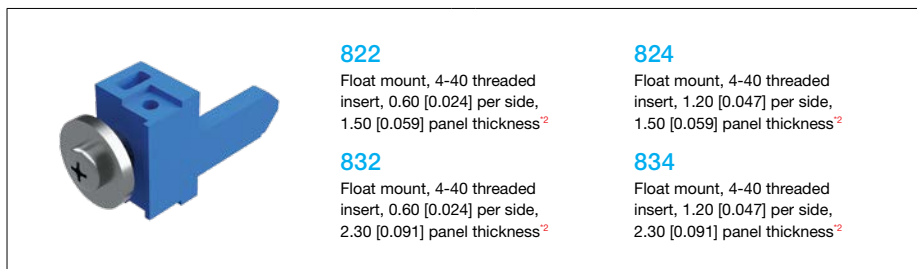
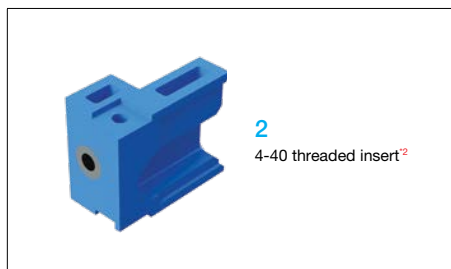
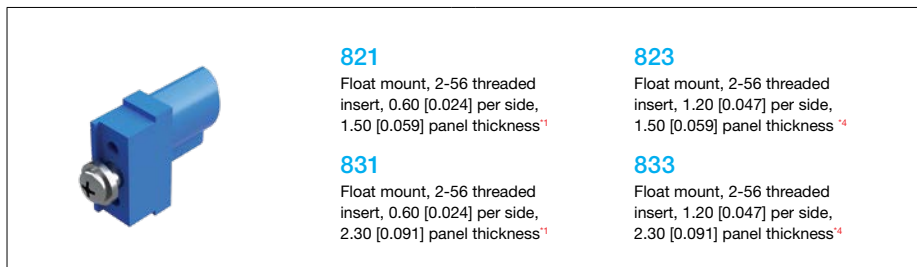
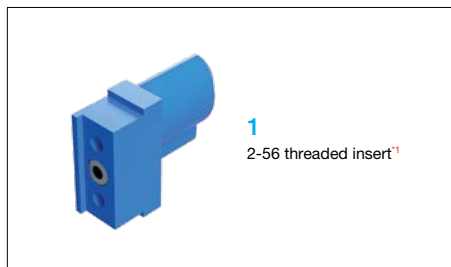

<sup>\*1</sup> For use with code 1 or 2 in Body Style step.  
<sup>\*2</sup> For use with code 8 in Body Style step.  
<sup>\*3</sup> For use with code 1, 2, 4 or 5 in Body Style step, contact Technical Sales for more floating options.  
<sup>\*4</sup> For use with code 1 in Body Style step, contact Technical Sales for more floating options.

CODE	MATERIALS
1, 2	Brass
82, 83, 821, 822, 823, 824, 831, 832, 833, 834	Steel with zinc plate

## ACCESSORIES

### JACKPOST/JACKSCREW SYSTEMS

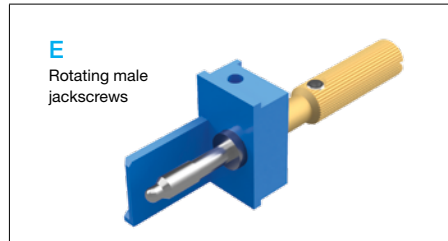
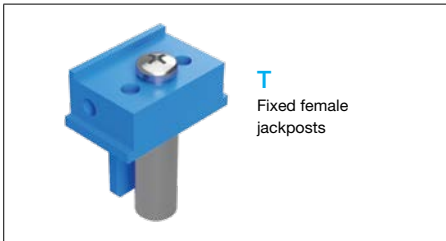
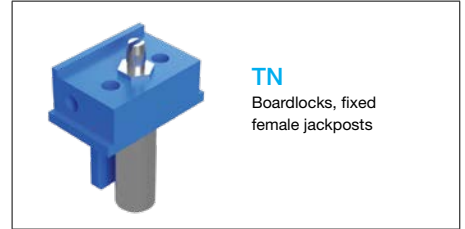
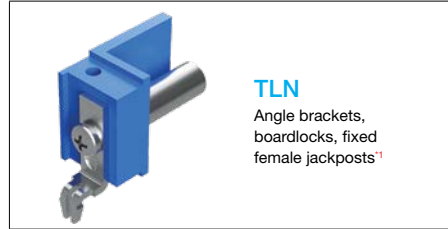
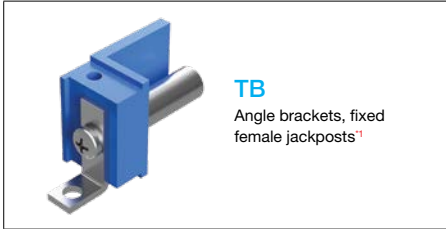

<sup>\*1</sup> For use with right angle PCB mount using code 4 or 48 in Termination step.

MATERIALS	
<b>Screw</b>	Steel with zinc plate
<b>Jackpost, hex nut and lock washer</b>	Stainless steel, passivated
<b>Knobs</b>	Aluminum, yellow anodized

### BACKSHELL

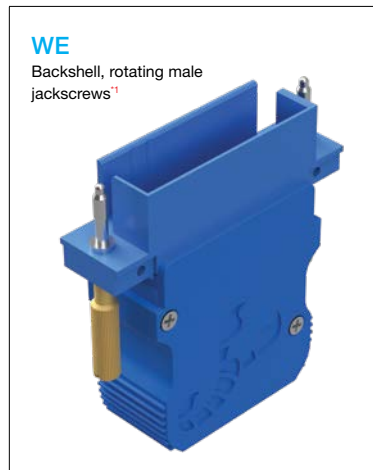
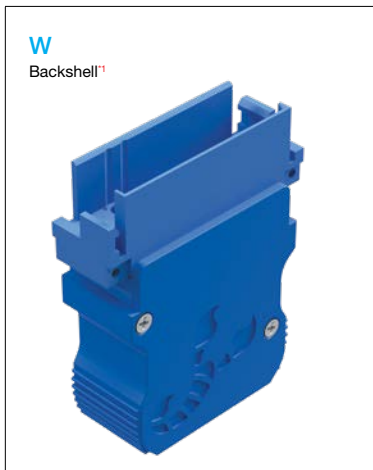

<sup>\*1</sup> For use with two N5 spacer modules in Layout step, one spacer will be needed on each end of connector.

MATERIALS	
<b>Backshell</b>	Glass-filled polyester, UL94 V-0, blue
<b>Screws</b>	Steel, zinc plate with chromate seal
<b>Cable clamp</b>	Steel with nickel plate
<b>Cable clamp screws</b>	Brass, zinc plate with chromate seal



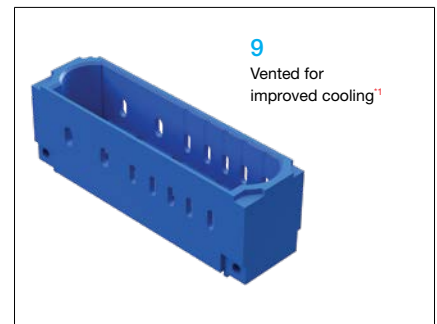
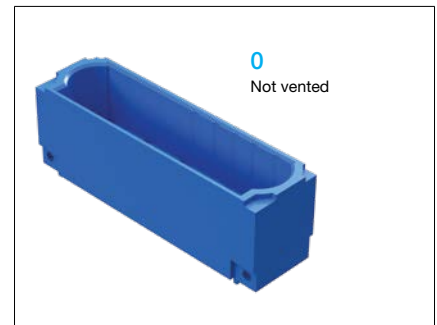

### VENTING FEATURES

Venting feature is a outlet hole enabling air cooling onto a power contact. In compliance with UL 1977, section 10.2 accessibility of live parts.



<sup>\*1</sup> Not for use with module A in Layout step or with signal contacts.

See [connectpositronic.com/Scorpion](http://connectpositronic.com/Scorpion) for all other Scorpion-related information including:

- ✓ **Footprints** 
- ✓ **Tooling** 
- ✓ **Product updates** 
- ✓ **Detailed dimensions** 
- ✓ **2D/3D drawings** 

All dimensional tolerances are  $\pm 0.38$  [0.015], unless otherwise specified:  $\pm 0.03$  mm [0.001 inches] for male contact mating diameters;  $\pm 0.08$  mm [0.003 inches] for contact termination diameters;  $\pm 0.13$  mm [0.005 inches] for all other diameters;  $\pm 0.38$  mm [0.015 inches] for all other dimensions. Dimensions are in millimeter [inches]. All dimensions are subject to change. Product pictures may not be identical in appearance to actual production parts.

Information in this catalog is proprietary to Positronic and its subsidiaries. Positronic believes the data contained herein to be reliable. Since the technical information is given free of charge, the user employs such information at his own discretion and risk. Positronic assumes no responsibility for results obtained or damages incurred from use of such information in whole or in part.

The following trademarks are owned by Positronic Industries, Inc.: Positronic Industries, Inc.®, Positronic®, Connector Excellence®, P+ logo®, PosiBand®, PosiShop®, Optik-D™, and The Science of Certainty®. The color blue as it appears on various connectors is a trademark of Positronic Industries, Inc., Registered in U.S. Patent and Trademark Office.

Products described within this catalog may be protected by one or more of the following US patents:

#4,900,261 #5,255,580 #5,329,697 #6,260,268  
#6,835,079 #7,115,002 #8,944,697 #9,304,263

Patented in Canada, 1992 Other patents pending

**Federal Supply Code for Manufacturers**

Positronic Industries: 28198  
Positronic Industries SAS: FA7Y0  
Positronic Asia PTE LTD: QB952

**Positronic | Americas**

423 N Campbell Ave  
Springfield MO 65806 USA  
+1 800 641 4054  
info@connectpositronic.com

**Positronic | Europe**

46 route d'Engachies  
F-32020 Auch Cedex 9 France  
+33 5 6263 4491  
contact@connectpositronic.com

**Positronic | Asia**

3014A Ubi Rd 1 #07-01  
Singapore 408703  
+65 6842 1419  
singapore@connectpositronic.com

**Sales Offices**

Positronic has local sales representation all over the world. For the nearest sales office visit [www.connectpositronic.com/sales](http://www.connectpositronic.com/sales)