

JOHNSON®

Non Magnetic Connectors Product Catalog

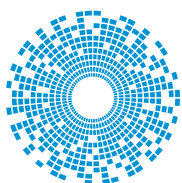

cinch
CONNECTIVITY SOLUTIONS
a bel group



**EAST
COAST
MICROWAVE**
SALES AND DISTRIBUTION, LLC.

Distributed by East Coast Microwave Sales & Distribution LLC
70 Tower Office Park, Woburn MA 01801. USA
Phone: 1.800.STOCKROOM - EMAIL: sales@ecmstockroom.com - WEB: www.ecmstockroom.com

NON-MAGNETIC RF CONNECTORS

Introduction



Johnson's Non-Magnetic Connector Additions Offer Solutions to MR Imaging Technology

Johnson, a product line of Cinch Connectivity Solutions, has expanded the connector product groups in its popular line of Non-Magnetic RF coaxial connectors and cable assemblies.

MCX and MMCX micro-miniature connectors have been added to satisfy the needs of the RF coil manufacturers that are building smaller coils for MRI equipment. Customized flex coils and array coils can image smaller parts of the body such as wrists, feet, hands and other appendages.

The Non-Magnetic MCX and MMCX is the perfect micro-miniature connector for small multichannel coil packages as they provide a positive snap-on coupling design with high mating cycles for rugged, high density connectivity.

The Type N Non-Magnetic connector provides a perfect RF solution for high Tesla fields considered for future designs. These deep tissue MR images will require the rugged interface of the N connector as well as the tri-alloy plating to eliminate inter-modulation issues.

All the connectors in Johnson's Non-Magnetic line are made from high purity copper alloys assuring no ferrous materials are in the connectors manufactured. Cinch Connectivity Solutions continues to work with our customers to develop new solutions as the MR industry transitions to high-end field applications and improved resolution at greater physical depths within the body.

Products are offered through authorized distributors and international sales channels including a direct sales force and a network of manufacturers' representatives. For more information, please call (800) 247-8256.

About Johnson

Cinch Connectivity Solutions, located in Waseca, MN, manufactures Johnson® RF Connectors such as Ultra-miniature (UMC), Micro-miniature (MCX, MCX 75, MMCX and SMP), Sub-miniature (SMA, SMB, SMB Mini-75 Ohm, SMK) and Medium (Type N) in the most popular styles including PC Board Mount, End Launch, Bulkhead Mount and Cable Mounts (Flexible, Semi-rigid and Conformable).

Table of Contents

MMCX Non-Magnetic RF Connectors	2
MCX Non-Magnetic RF Connectors	6
SMA Non-Magnetic RF Connectors	11
SMB Non-Magnetic RF Connectors	15
Type N Non-Magnetic RF Connectors	19
Assembly Instructions	22
The Johnson Combination	
MRI Connectors and Modular Customization	30
Competitor Cross Reference	31

NON-MAGNETIC RF CONNECTORS

MMCX Non-Magnetic RF Connectors



ELECTRICAL SPECIFICATIONS

Impedance:	50 Ohms		
Frequency Range	0-6 GHz		
VSWR: (f = GHz)		Straight Cable Connectors	Right Angle Cable Connectors
	.047 dia flexible	1.20	1.14 + .07f
	RG-178, RG-316, RG-316 DS	1.20	1.25
Working Voltage	170 VRMS at sea level		
Dielectric Withstanding Voltage	500 VRMS at sea level		
Insulation Resistance	1000 megohms minimum		
Contact Resistance (milliohms maximum)		Initial	After Environmental
	Center Contact (straight cabled connectors, uncabled receptacles)	5.0	8.0
	Center Contact (right angle cabled connectors)	5.0	15.0
	Outer Contact	1.0	1.5
	Braid to Body	1.5	N/A
Corona Level:	190 volts min at 70,000 feet		
Insertion Loss (dB maximum, tested at 1 GHz)			
	Straight Cable Connectors		0.1
	Right Angle Cable Connectors		0.2
	Uncabled Receptacles		N/A
RF Leakage (dB minimum tested at 2.5 GHz)			
	Flexible Cable Connectors		-60 dB
RF High Potential Withstanding Voltage	tested at 4 and 7 MHz		
	VRMS minimum		400

MECHANICAL SPECIFICATIONS

Engagement Design	Series MMCX		
Engagement Force	8 lbs. max axial engagement, 1.4 lbs. min axial disengagement		
Contact Retention	2.0 pounds min. axial force, 1 inch-ounce min. torque (uncabled receptacles)		
Cable Retention		Axial Force* (lbs)	Torque (in-oz)
	Connectors for .047 flexible	3.5	N/A
	Connectors for RG-178	7.0	N/A
	Connectors for RG-316	20.0	N/A
	Connectors for RG-316 DS	25.5	N/A
	Connectors for .086 Semi-Rigid	30.0	16
	*Or cable breaking strength whichever is less.		
Durability:	500 cycles minimum		

ENVIRONMENTAL SPECIFICATIONS (Meets or Exceeds the Applicable Paragraph of MIL-RF-39012)

Temperature Range	-65°C to +165°C
Thermal Shock	MIL-STD-202, Method 107, Condition C (Except -55°C to 115°C)
Corrosion	MIL-STD-202, Method 101, Condition B
Shock	MIL-STD-202, Method 213, Condition B
Vibration	MIL-STD-202, Method 204, Condition D
Moisture Resistance	MIL-STD-202, Method 106

NON-MAGNETIC RF CONNECTORS



MMCX Non-Magnetic RF Connectors For Flexible Cable and PC Mount

Straight Crimp Type Plug - Solder or Crimp Contact - Captivated Contact

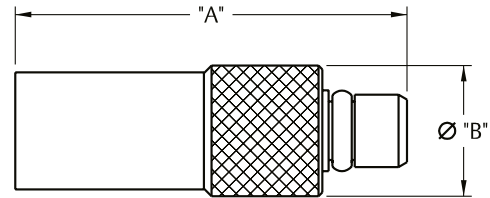

Cable Type	Gold Plated	"A"	"B"	Termination
RG-316/U, 188, 161, 174	135-9403-001	.509 (12.93)	.173 (4.39)	Crimp Sleeve
RG-178/U, 196	135-9402-001	.462 (11.73)	.137 (3.48)	Crimp Insert
.047 Dia. Flex	135-9436-001	.462 (11.73)	.137 (3.48)	Crimp Insert

See assembly instructions page 22

Right Angle Crimp Type Plug - Captivated Contact

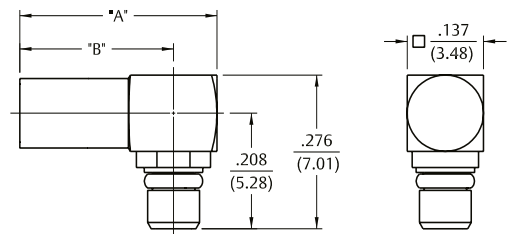

Cable Type	Gold Plated	"A"	"B"	Termination
RG-316/U, 188, 187, 179, 161, 174	135-9403-101	.412 (10.46)	.334 (8.48)	Crimp Sleeve
RG-178/U, 196	135-9402-111	.412 (10.46)	.334 (8.48)	Crimp Sleeve
.047 Dia. Flex	135-9436-101	.354 (8.99)	.276 (6.98)	Crimp Insert

See assembly instructions page 23

Straight Jack Receptacle

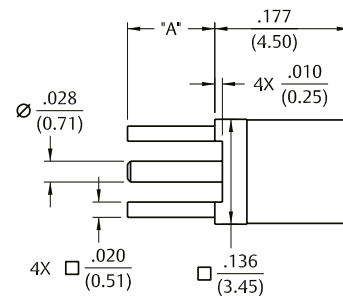

Gold Plated	"A"
135-9701-201	.115 (2.92)
135-9701-211	.068 (1.73)

Mounting hole layout figure 1 on page 5

NON-MAGNETIC RF CONNECTORS



MMCX Non-Magnetic RF Connectors For PC Mount

Right Angle Jack Receptacle

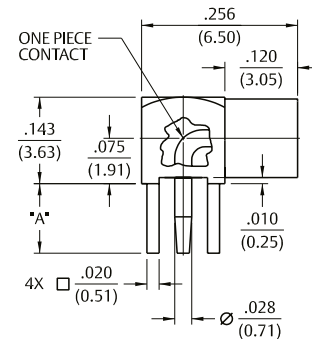

Gold Plated	"A"
135-9701-301	.155 (3.94)
135-9701-311	.068 (1.73)

Mounting hole layout figure 1 on page 5 below

End Launch Jack Receptacle - Surface Contact

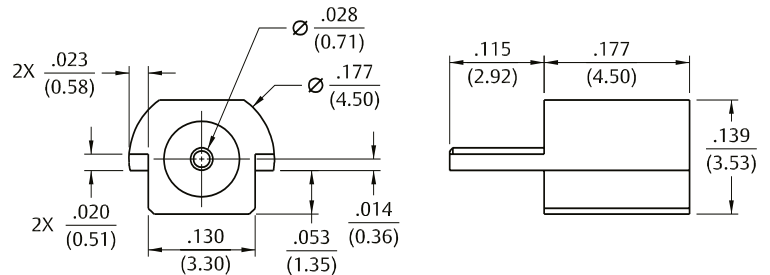
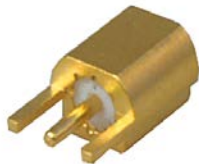

Gold Plated	Packaging
135-9711-801	Stock
135-9711-802	Tape and Reel 1000 pcs/reel

Recommended land pattern figure 2 on page 5

Mounting Hole Layout

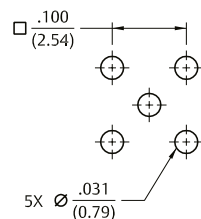

Fig 1

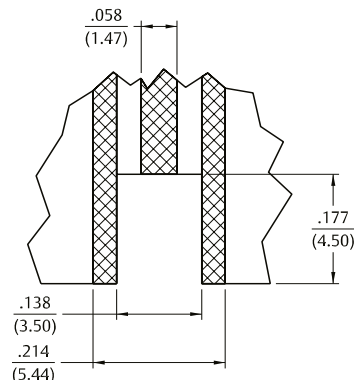

Fig 2

NON-MAGNETIC RF CONNECTORS

MCX Non-Magnetic RF Connectors



ELECTRICAL SPECIFICATIONS			
Impedance:		50 Ohms	
Frequency Range		0-6 GHz	
VSWR: (f = GHz)		Straight Cable Connectors	Right Angle Cable Connectors
	RG-178 cable	1.17 + .09f	1.07 + .06f
	RG-316 cable	13 + .04f	1.07 + .04f
	Uncabled Receptacles	N/A	N/A
Working Voltage (VRMS maximum)	Connectors for Cable Type	Sea Level	70K Feet
	RG-178	250	65
	RG-316	335	85
Dielectric Withstanding Voltage (VRMS minimum at sea level)	Connectors for RG-178, Uncabled Receptacles		750
	Connectors for RG-316, Uncabled Receptacles		1000
Insulation Resistance	10,000 megohms minimum		
Contact Resistance (milliohms maximum)		Initial	After Environmental
	Center Contact (straight cabled connectors, uncabled receptacles)	5.0	8.0
	Center Contact (right angle cabled connectors)	5.0	15.0
	Outer Contact	1.0	1.5
	Braid to Body	1.0	N/A
Corona Level (Volts minimum at 70,000 feet)	Connectors for RG-178 Uncabled Receptacles		190
	Connectors for RG-316, Uncabled Receptacles		250
Insertion Loss (dB maximum, tested at 1 GHz)	Straight Cable Connectors		0.1
	Right Angle Cable Connectors		0.2
	Uncabled Receptacles		N/A
RF Leakage (dB minimum tested at 2.5 GHz)	Cable connectors		-55
	Uncabled receptacles		N/A
RF High Potential Withstanding Voltage	(VRMS minimum, tested at 4 and 7 MHz)		
	Connectors for RG 178		500
	Connectors for RG 316		700
	Uncabled Receptacles		600

MECHANICAL SPECIFICATIONS			
Engagement Design	Compatible with CECC 22220, Series MCX		
Engagement / Disengagement Force	5.6 pounds maximum axial force / 8 pounds maximum axial force, 1 pound min		
Contact Retention	2.3 pounds min. axial force (captivated contacts); 1 inch-ounce min. torque (uncabled receptacles)		
Cable Retention		Axial Force* (lbs)	Torque (in-oz)
	Connectors for RG178	10	N/A
	Connectors for RG316	20	N/A
	Connectors for RG316 DS	25	N/A
	*Or cable breaking strength whichever is less.		
Durability:	500 cycles minimum		

ENVIRONMENTAL SPECIFICATIONS (Meets or Exceeds the Applicable Paragraph of MIL-RF-39012)	
Temperature Range	-65°C to +165°C
Thermal Shock	MIL-STD-202, Method 107, Condition C (Except -55°C to 115°C)
Corrosion	MIL-STD-202, Method 101, Condition B
Shock	MIL-STD-202, Method 213, Condition B
Vibration	MIL-STD-202, Method 204, Condition D
Moisture Resistance	MIL-STD-202, Method 106

NON-MAGNETIC RF CONNECTORS

MCX Non-Magnetic RF Connectors



Straight Crimp Type Plug - Solder or Crimp Contact - Captivated Contact

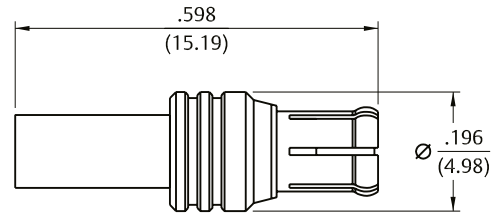

Cable Type	Gold Plated
RG-178	133-9402-001
RG-316/U, 188, 174	133-9403-001
RG-316 DS, 188 DS	133-9404-001

See assembly instructions page 24

Straight Crimp Type Jack Receptacle

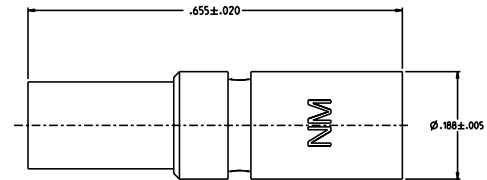

Cable Type	Gold Plated
RG-316	133-9303-001

Right Angle Crimp Type Plug - Captivated

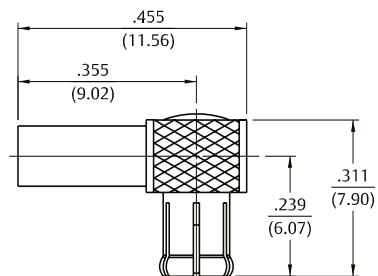

Cable Type	Gold Plated	Silver Plated
RG-316/U, 188, 174	133-9403-101	133-9403-104
RG-316 DS, 188 DS	133-9404-101	
RG-178/U, 196	133-9402-101	

See assembly instructions page 24

NON-MAGNETIC RF CONNECTORS



MCX Non-Magnetic RF Connectors For Flexible Cables

Straight Jack Receptacle

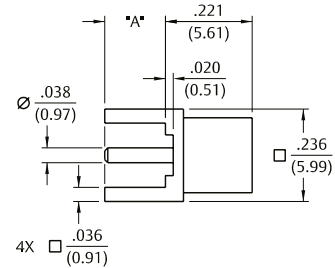

Gold Plated	Silver Plated	"A"
133-9701-201	133-9701-204	.155 (3.94)
133-9701-211		.110 (2.79)

Mounting hole layout figure 4 on page 10

Straight Plug Receptacle, PCB Mount

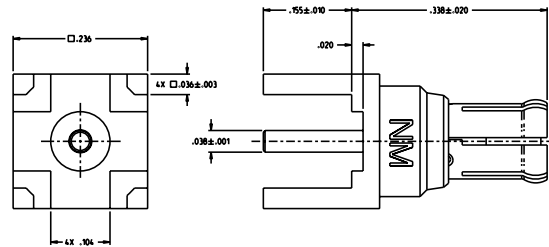
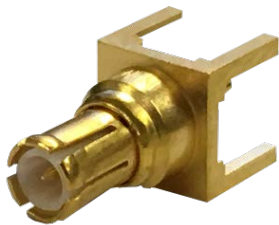

Gold Plated
133-9801-201

Straight Surface Mount, Jack Assembly

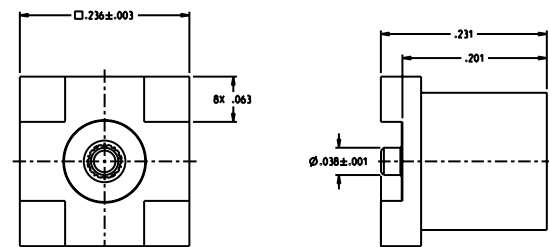

Gold Plated
133-9711-201

NON-MAGNETIC RF CONNECTORS



MCX Non-Magnetic RF Connectors For Flexible Cables

Straight Jack Receptacle - .100" Layout

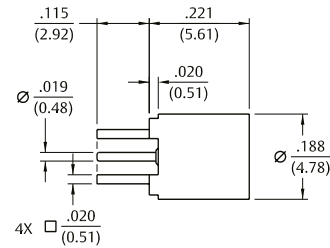

Gold Plated

133-9701-231

Mounting hole layout figure 3 on page 10

Right Angle Jack Receptacle

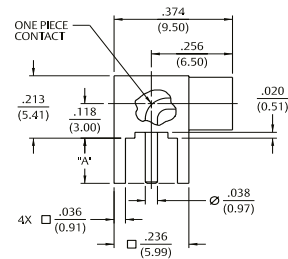

Gold Plated

133-9701-301

Silver Plated

133-9701-304

"A"

.155 (3.94)

133-9701-311

.110 (2.79)

Mounting hole layout figure 4 on page 10

End Launch Jack Receptacle - Round Contact

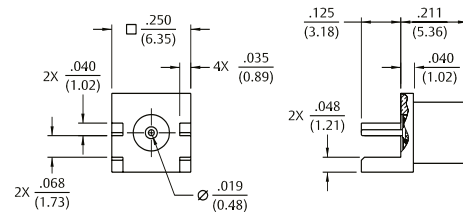

Gold Plated

133-9701-801

Board Thickness

.062 (1.57)

MCX Non-Magnetic RF Connectors For PC Mount

Mounting Holes Layout

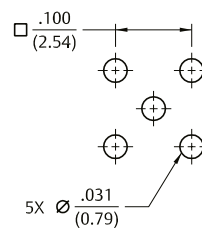

Fig 3

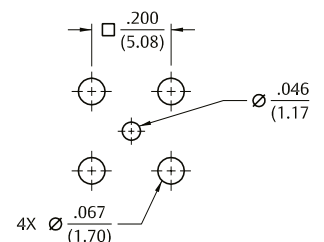

Fig 4

NON-MAGNETIC RF CONNECTORS



SMA Non-Magnetic RF Connectors

ELECTRICAL SPECIFICATIONS			
Impedance:			50 Ohms
Frequency Range	Flexible cable connectors Uncabled Receptacles		0-12.4 GHz 0-18.0 GHz
VSWR: (f = GHz)		Straight Cable Connectors	Right Angle Cable Connectors
	RG-316	1.15 + .02f	1.15 + .03f
	RG-58	1.15 + .01f	1.15 + .02f
	Uncabled Receptacles	N/A	N/A
Working Voltage (VRMS maximum)	Connectors for Cable Type	Sea Level	70K Feet
	RG-316	250	65
	RG-58, Uncabled Receptacles	335	85
Dielectric Withstanding Voltage (VRMS minimum at sea level)			
	Connectors for RG-316		750
	Connectors for RG-58, Uncabled Receptacles		1000
Insulation Resistance	5000 megohms minimum		
Contact Resistance (milliohms maximum)		Initial	After Environmental
	Center Contact (straight cabled connectors, uncabled receptacles)	3.0	4.0
	Center Contact (right angle cabled connectors)	4.0	6.0
	Outer Contact	2.0	N/A
	Braid to Body	0.5	N/A
Corona Level (Volts minimum at 70,000 feet)			
	Connectors for RG-316		190
	Connectors for RG-58, Uncabled Receptacles		250
Insertion Loss (dB maximum, tested at 1 GHz)			
	Straight Cable Connectors		0.06 √f(GHz), tested at 6 GHz
	Right Angle Cable Connectors		0.15 √f(GHz), tested at 6 GHz
	Uncabled Receptacles		N/A
RF Leakage (dB minimum tested at 2.5 GHz)			
	Cable connectors		-60 dB
	Uncabled Receptacles		N/A
RF High Potential Withstanding Voltage	(VRMS minimum, tested at 4 and 7 MHz)		
	Connectors for RG-316		500
	Connectors for RG-58, Uncabled receptacles		670
MECHANICAL SPECIFICATIONS			
Engagement Design	MIL-STD-348, Series SMA		
Engagement / Disengagement Force	2 inch-pounds maximum		
Contact Retention	6 lb minimum axial force (captivated contacts); 4 inch-ounce minimum torque (uncabled receptacles)		
Mating Torque	7 to 10 inch-pounds		
Coupling Proof Torque	15 inch-pounds minimum		
Coupling Nut Retention	60 pounds minimum		
Cable Retention		Axial Force* (lbs)	Torque (in-oz)
	Connectors for RG-316	20	N/A
	Connectors for RG-58	40	N/A
	*Or cable breaking strength whichever is less.		
Durability:	500 cycles minimum		
ENVIRONMENTAL SPECIFICATIONS (Meets or Exceeds the Applicable Paragraph of MIL-RF-39012)			
Temperature Range	-65°C to +165°C		
Thermal Shock	MIL-STD-202, Method 107, Condition B		
Corrosion	MIL-STD-202, Method 101, Condition B		
Shock	MIL-STD-202, Method 213, Condition I		
Vibration	MIL-STD-202, Method 204, Condition D		
Moisture Resistance	MIL-STD-202, Method 106		

NON-MAGNETIC RF CONNECTORS



SMA Non-Magnetic RF Connectors For Flexible and Semi-Rigid Cable

Straight Solder Type Plug, Semi Rigid Cable

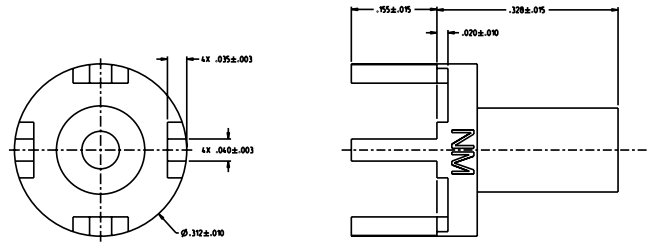

Gold Plated

142-9003-201

Straight Crimp Type Plug (3-piece) - Captivated Contact

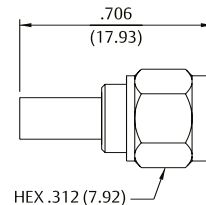

Cable Type	VSWR & Freq. Range	Gold Plated
RG-316/U, 188, 174	1.15 + .02f (GHz) 0-12.4 GHz	142-9403-011
RG-316 DS, 188 DS	1.15 + .02f (GHz) 0-12.4 GHz	142-9404-011
RG-58/U, 141	1.15 + .01f (GHz) 0-12.4 GHz	142-9407-001

See assembly instructions page 25

Right Angle Crimp Type Plug - Captivated Contact

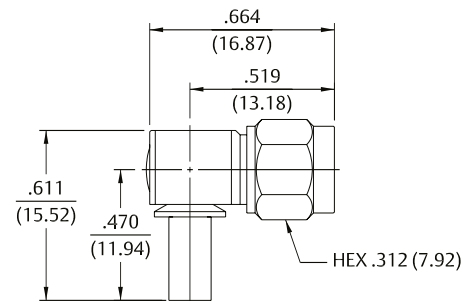

Cable Type	VSWR & Freq. Range	Gold Plated	Silver Plated
RG-316/U, 188, 174	1.15 + .03f (GHz) 0-12.4 GHz	142-9403-101	142-9403-104
RG-316 DS, 188 DS	1.15 + .03f (GHz) 0-12.4 GHz	142-9404-101	
RG-58/U, 141	1.15 + .02f (GHz) 0-12.4 GHz	142-9407-101	142-9407-104

See assembly instructions page 25

NON-MAGNETIC RF CONNECTORS



SMA Non-Magnetic RF Connectors For PC Mount

Straight Crimp Type Blukhead Jack (3-piece) - Captivated Contact

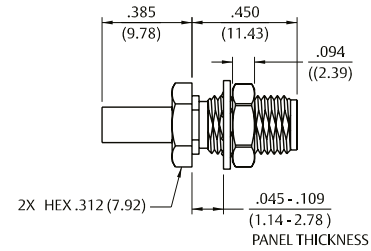

Cable Type	VSWR & Freq. Range	Gold Plated
RG-316/U, 188, 174	1.15 + .02f (GHz) 0-12.4 GHz	142-9303-411

See assembly instructions page 25

Mounting hole layout figure 5 on page 14

Straight Jack Receptacle

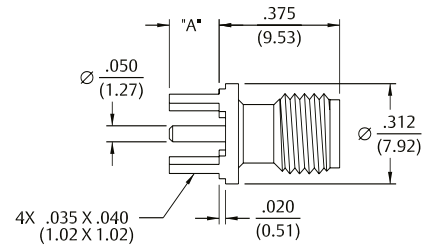

Frequency Range	Gold Plated	"A"
0-18 GHz	142-9701-201	.155 (3.94)
0-18 GHz	142-9701-211	.110 (2.79)

Mounting hole layout figure 6 on page 14

Straight Plug Receptacle

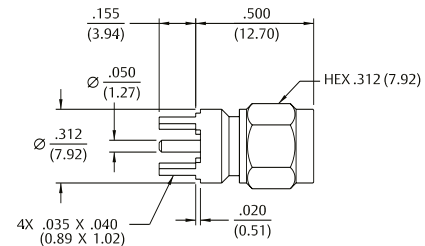

Frequency Range	Gold Plated
0-18 GHz	142-9801-201

Mounting hole layout figure 6 on page 14

NON-MAGNETIC RF CONNECTORS



SMA Non-Magnetic RF Connectors For PC Mount

Right Angle Receptacle

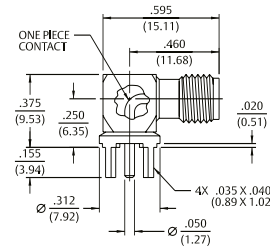

Frequency Range	Gold Plated
0-18 GHz	142-9701-301

Mounting hole layout figure 6 on page 14

End Launch Receptacle - Round Contact

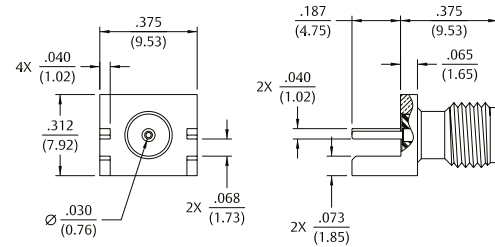

Frequency Range	Gold Plated	Board Thickness
0-10 GHz	142-9701-801	.062 (1.57)

End Launch Receptacle - Tab Contact

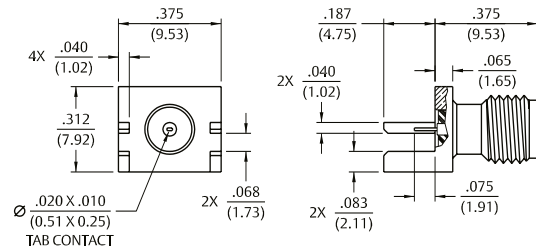

Frequency Range	Gold Plated	Board Thickness
0-10 GHz	142-9701-811	.062 (1.57)

Mounting hole layout

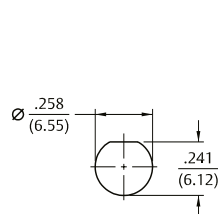

Fig 5

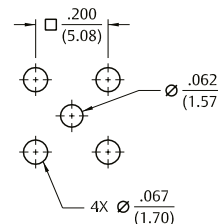

Fig 6

NON-MAGNETIC RF CONNECTORS



SMB Non-Magnetic RF Connectors

ELECTRICAL SPECIFICATIONS			
Impedance:		50 Ohms	
Frequency Range	Connectors	0 - 4 GHz	
VSWR: (f = GHz)		Straight Cable Connectors	Right Angle Cable Connectors
	RG-316 Uncabled Receptacles	1.25 + .04f N/A	1.35 + .04f N/A
Working Voltage (VRMS maximum)	Connectors for Cable Type	Sea Level	70K Feet
	RG-316, Uncabled Receptacles	335	85
Dielectric Withstanding Voltage (VRMS minimum at sea level)	Connectors for RG-316, Uncabled Receptacles	1000	
Insulation Resistance		1000 megohms minimum	
Contact Resistance (milliohms maximum)		Initial	After Environmental
	Center Contact (straight cabled connectors, uncabled receptacles)	6.0	8.0
	Center Contact (right angle cabled connectors)	12.0	16.0
	Outer Contact	1.0	1.5
	Braid to Body	.10	N/A
Corona Level (Volts minimum at 70,000 feet)	Connectors for RG-316 Uncabled Receptacles		250 N/A
Insertion Loss (dB maximum, tested at 1.5 GHz)	Straight Cable Connectors Right Angle Cable Connectors Uncabled Receptacles		0.3 dB 0.6 dB N/A
RF Leakage (dB minimum tested at 2.5 GHz)	Cable Connectors Uncabled Receptacles		-55 dB N/A
RF High Potential Withstanding Voltage	(VRMS minimum, tested at 4 and 7 MHz)		
	Connectors for RG-316 Uncabled Receptacles		700 600

MECHANICAL SPECIFICATIONS			
Engagement Design	MIL-STD-348, Series SMB		
Engagement / Disengagement Force	2 pounds min to 14 pounds maximum axial force / 4 lb minimum axial force (captivated contacts)		
Contact Retention	4 lb minimum axial force (captivated contacts); 1 inch-ounce minimum torque (uncabled receptacles)		
Cable Retention	Connectors for RG316 *Or cable breaking strength whichever is less.	Axial Force* (lbs) 20	Torque (in-oz) N/A
Durability:	500 cycles minimum		

ENVIRONMENTAL SPECIFICATIONS (Meets or Exceeds the Applicable Paragraph of MIL-RF-39012)	
Temperature Range	-65°C to +165°C
Thermal Shock	MIL-STD-202, Method 107, Condition B
Corrosion	MIL-STD-202, Method 101, Condition B
Shock	MIL-STD-202, Method 213, Condition I

NON-MAGNETIC RF CONNECTORS



SMB Non-Magnetic RF Connectors For Flexible Cable

Straight Crimp Type Plug - Solder or Crimp Captivated Contact

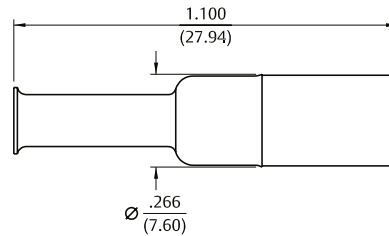

Cable Type	Gold Plated
RG-316/U, 188, 174, 179, 187	131-9403-001
RG-316 DS, 188 DS, 179 DS, 187 DS	131-9404-001

See assembly instructions page 27

Straight Crimp Type Plug (3-piece), Solder or Crimp Captivated Contact

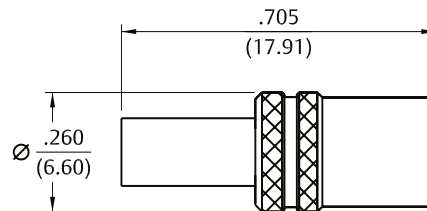

Cable Type	Gold Plated
RG-316/U, 188, 174, 179, 187	131-9403-021
RG-316 DS, 188 DS, 179 DS, 187 DS	131-9404-021

See assembly instructions page 27

Right Angle Crimp Type Plug - Captivated Contact

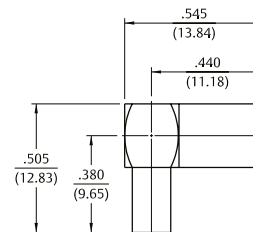

Cable Type	Gold Plated
RG-316/U, 188, 174, 179, 187	131-9403-101
RG-316 DS, 188 DS, 179 DS, 187 DS	131-9404-101

See assembly instructions page 27

NON-MAGNETIC RF CONNECTORS



SMB Non-Magnetic RF Connectors For Flexible Cable

Straight Jack Receptacle

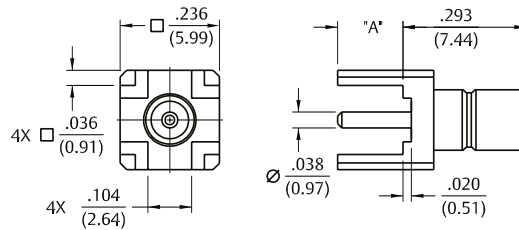

Gold Plated	"A"
131-9701-201	.155 (3.94)
131-9701-211	.095 (2.41)

Mounting hole layout figure 7 on page 18

Straight Bulkhead Jack, Crimp Type, Flexible Cable

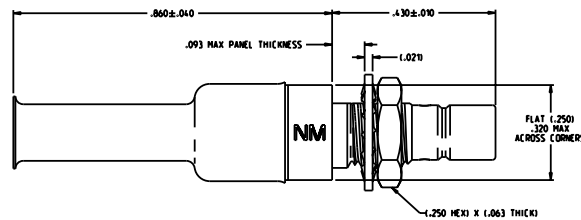

Gold Plated
131-9303-401

Right Angle Jack Receptacle

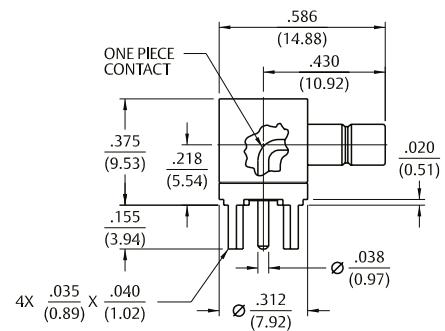

Gold Plated
131-9701-301

Mounting hole layout figure 7 on page 18

NON-MAGNETIC RF CONNECTORS



SMB Non-Magnetic RF Connectors For Flexible Cable

Mounting hole layout

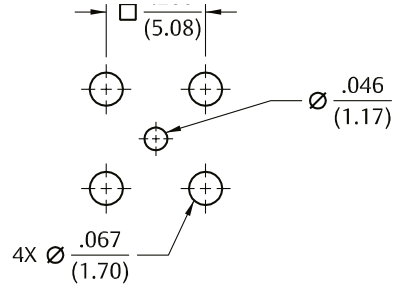

Fig 7

NON-MAGNETIC RF CONNECTORS



Type N Non-Magnetic RF Connectors

ELECTRICAL SPECIFICATIONS			
Impedance:			50 Ohms
Frequency Range	Flexible Cabled and Receptacles		0-11 GHz
VSWR: (f = GHz)			0-11 GHz
	Straight Flexible Cabled Uncabled Receptacles		1.3 max N/A
Working Voltage (VRMS maximum)	Connectors for Cable Type	Sea Level	70K Feet
	RG-55/U	335	85
	RG-214, LMR-400 Cabled	1000	250
	Uncabled Receptacles	1000	250
Dielectric Withstanding Voltage (VRMS minimum at sea level)			
	RG-55		1000
	RG-214, LMR-400 Cabled		2500
	Uncabled Receptacles		2500
Insulation Resistance	5000 megohms minimum		
Contact Resistance (milliohms maximum)		Initial	After Environmental
	Straight Cabled (non-captivated)	1.0	1.5
	Straight Cabled (captivated)	2.5	3.0
	Uncabled Receptacles	1.0	1.5
	Outer contact	0.2	N/A
	Braid to body	0.05	N/A
Corona Level (Volts minimum at 70,000 feet)			
	RG-55		250
	RG-214, LMR-400 Cabled		500
	Uncabled Receptacles		N/A
Insertion Loss (dB maximum, tested at 9 GHz)			
	Straight Cable Connectors		0.15 max
	Right Angle Cable Connectors		0.30 max
	Uncabled Receptacles		N/A
RF Leakage (dB minimum tested at 2.5 GHz)			
	Cable connectors		90
	Uncabled receptacles		N/A
RF High Potential Withstanding Voltage	(VRMS minimum, tested at 4 and 7 MHz)		
	RG-55		670
	RG-214, LMR-400 Cabled		1500
	Uncabled Receptacles		1500
IMP3			Typically < -90 dBm

(tested per IEC Guidelines using 20 W inputs swept over 1930-1990 MHz)

MECHANICAL SPECIFICATIONS			
	Cabled Connectors	Axial Force (lbs)	Torque (in-oz)
	Uncabled Receptacles	6	N/A
		6	4
Cable Retention (minimum*)		Axial Force (lbs)	Torque (in-oz)
	RG-55 Cabled	45	N/A
	RG-214, LMR-400 Cabled	90	N/A
	*Or cable breaking strength whichever is less.		

ENVIRONMENTAL SPECIFICATIONS			
Engagement Design	MIL-STD-348A, Series N	Bulkhead Mounting Nut Torque	15 inch-pounds recommended
Engagement / Disengagement Force	6 inch-pounds maximum	Coupling Proof Torque	15 inch-pounds minimum
Durability	500 Cycles minimum	Coupling Nut Retention	100 pounds minimum
Mating Torque	7 to 10 inch-pounds	Contact Retention	minimum - captivated contacts only

NON-MAGNETIC RF CONNECTORS



Type N Non-Magnetic RF Connectors For Flexible Cable

Straight Crimp Type Plug – Solder or Crimp Contact

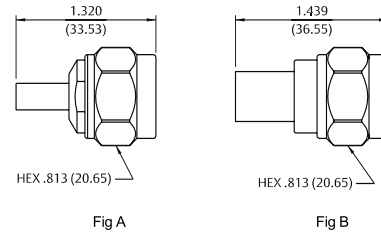

Cable Type	VSWR & Freq. Range	Tri-Alloy Plated Figure
RG-55/U, 142, 223, 400	1.30 Max, 0-11 GHz	138-9408-007 A
LMR-400, BELDEN 9913	1.30 Max, 0-11 GHz	138-9449-007 B

See assembly instructions page 28

Right Angle Crimp Type Plug – Captivated Contact

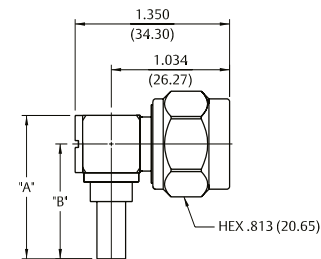

Cable Type	VSWR & Freq. Range	Tri-Alloy Plated	"A"	"B"
RG-55/U, 142, 223, 400	1.35 Max, 0-9 GHz 1.50 Max, 9-11 GHz	138-9408-107	1.253 (31.83)	1.003 (25.48)
RG-9/U, 214	1.35 Max, 0-9 GHz 1.50 Max, 9-11 GHz	138-9418-107	1.365 (34.67)	1.115 (28.32)

See assembly instructions page 28

Straight Crimp Type Bulkhead Jack – Solder or Crimp Contact

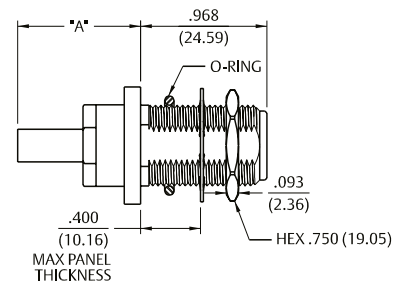

Cable Type	VSWR & Freq. Range	Tri-Alloy Plated	"A"
RG-55/U, 142, 223, 400	1.30 Max, 0-11 GHz	138-9308-407	.943 (23.95)
LMR-400, BELDEN 9913	1.30 Max, 0-11 GHz	138-9349-407	.997 (25.32)

See assembly instructions page 28

Mounting hole layout figure 8 on page 21

NON-MAGNETIC RF CONNECTORS



Type N Non-Magnetic RF Connectors For Bulkhead and Flange Mount

Rear Mount Bulkhead Jack Receptacle

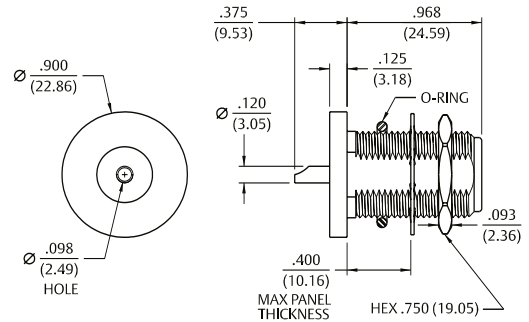

Freq. Range	Tri-Alloy Plated
0-11 GHz	138-9701-407

Mounting hole layout figure 8 on page 21 (below)

4-Hole Flange Mount Jack Receptacle – Flush Dielectric

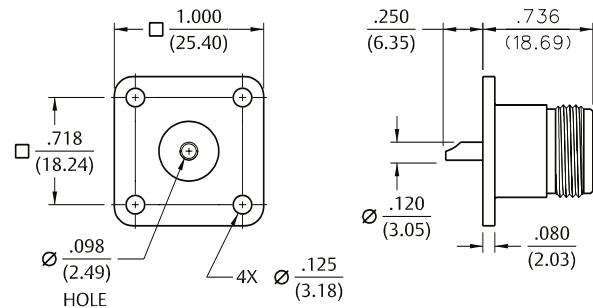

Freq. Range	Tri-Alloy Plated
0-11 GHz	138-9701-607

Mounting hole layout figure 8 on page 21 (below)

Mounting Hole Layout

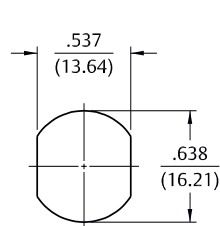

Fig 8

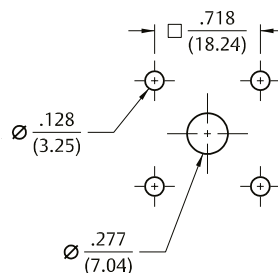

Fig 9



Distributed in the USA by



Contact Information:

Telephone: +1 (800) STOCKROOM
EMAIL: sales@ecmstockroom.com
ON-LINE STORE: www.ecmstockroom.com